

Specifications

Concrete: Minimum Compressive Strength is 5,000 PSI @ 28 Days.

Reinforcing: Primary reinforcement will be cover, side and bottom, #3 and / or #4 Rebar (Grade 60).

Sealant: Butyl Sealant used in the seam of the tank and risers will meet or exceed ASTM C990.

Inlet and Outlet Openings: Are fitted with Pipe-to-Structure connectors that meet or exceed ASTM C923.

Earth Cover: Minimum 2' to Maximum 8'.

Design Data: Design per ASTM C1227. Not traffic rated, consult Lake Shore Burial Vault if required.

Installation: The excavated hole is not to be more than one foot longer and wider than the tank. There shall be a minimum bedding of 4" of washed sand or stone less than 1" in size in soil terrain and 8" bedding in rock terrain. Backfilling around tanks with material describe above is suggested when cover is 4' or greater.

Tank Warranty: Lake Shore Burial Vault Company's tanks are warranted against defective materials and / or workmanship for One year from the date of delivery when installed with manufacturer's instructions. Should a defect appear within the warranty period, Lake Shore Burial Vault will supply a new tank in replacement thereof. Lake Shore Burial Vault's liability is limited to the value of the tank itself and specifically excludes the cost of installation and/or removal and any subsequent damages. Failure to follow installation procedures and general notes will void the warranty.

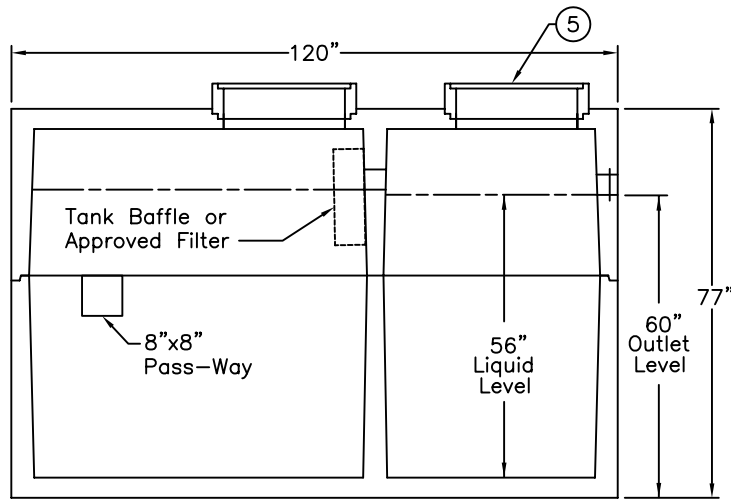

SECTION A-A

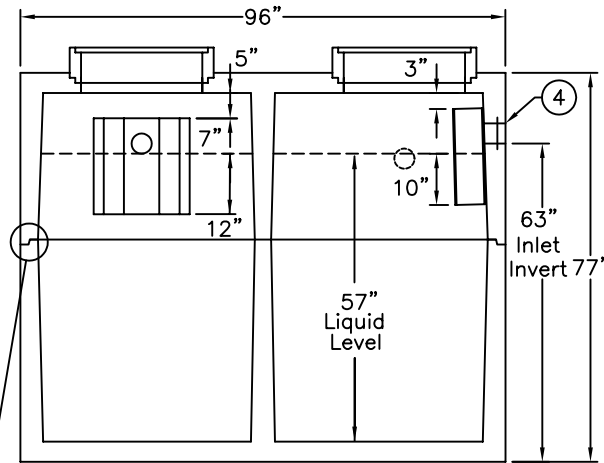

SECTION B-B

Butyl Sealant

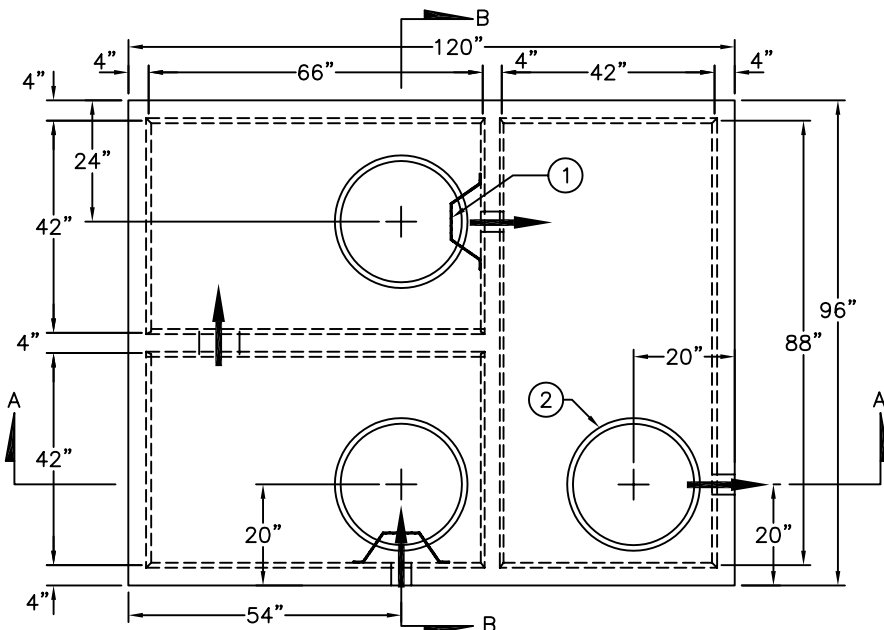

NOT TO SCALE

PLAN VIEW - TOP SLAB

Item No	Description
1	Tank Baffle - HDPE
2	Riser - 24" Dia
3	Boss Stop
4	Pipe-To-Structure Connector
5	Manhole Cover
6	Tank Baffle - PVC

Lake Shore Burial Vault Co., Inc

12780 W. Lisbon Road
Brookfield, WI 53005

Phone: 262.781.6262 Fax: 262.781.6280
www.lsburialvaults.com

General Notes:

This drawing is the property of Lake Shore Burial Vault Company and shall not be copied or submitted without the consent of this company. All vertical measurements are accurate within +/- 1" on the tank.

Model: 2,250 Gallon, Three Compartment, Mid-Seam Tank

Drawn By: MR Date: 2/22/10 Approx Weight: 10,880 lbs - T
12,640 lbs - B

Capacity: 680/680/890 Dwg. No: 02250.00SSP
GPI: 12.00/12.00/16.00